

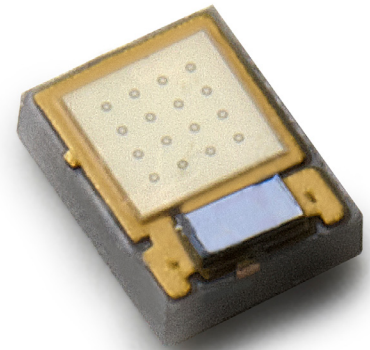

LUXEON Z UV

Superior flux density, efficiency and design freedom — in the industry's only micro-package UV LED

At 1/5th the size of other ultraviolet and violet LEDs, LUXEON Z UV LEDs, a SMT device, can be assembled in tight arrays with spacing of only 200 microns, which enables high power density (W/cm^2) system for superior efficiency and design freedom. The product is undomed for precise optical control, and a portfolio covering ultraviolet and violet light. The superior quality of light, volume of lumens, and real world efficacy enable leading performance and efficient solution development in a wide variety of indoor and outdoor lighting segments.



FEATURES AND BENEFITS

Offering ultraviolet in 380-400nm and violet (400-430nm) for a range of options

Small 2.2mm² SMT footprint enables highest W/cm^2 systems, design flexibility

1A max drive current allows more flux per LED

Up to 45%+ efficiency reduces heat output

AIN package of as low as 3.5 K/W for better thermal management

PRIMARY APPLICATIONS

Specialty Lighting

Table of Contents

General Information	2
Test Conditions	2
Product Nomenclature	2
Safety	2
Radiant Flux Characteristics,	3
Other Characteristics,	4
Absolute Maximum Ratings	4
Mechanical Dimensions	5
Solder Pad Design	5
JEDEC Moisture Sensitivity	6
Reflow Soldering Characteristics	6
Typical Characteristic Curves	7
Typical Radiation Patterns	10
Flux and Wavelength Bin Availability	11
Emitter Pocket Tape Packaging	12
Emitter Reel Packaging	13

General Information

Test Conditions

LUXEON Z UV emitters are specified and binned at 500mA, 20ms monopulse, and junction temperature of 25°C.

Product Nomenclature

The part number designation for LUXEON Z UV is as follows:

L H UV – a B B B – c D D D

Where:

a — open slot to accommodate additional requirements per product and part number. a is 0 by default

BBB — designates beginning of 5nm wavelength bin (for example, 395 for 395-400nm)

c — open slot to accommodate additional requirements per product and part number. c is 0 by default

DDD — designates minimum radiometric power in mW (for example, 500 for 500mW)

Safety

WARNING: LUXEON Z UV products emit ultraviolet light. Do not look at operating LEDs. Eye injury may result. Use necessary skin and eye protection. Assume IEC62471 Risk Group 3.

Radiant Flux Characteristics, $T_j = 25^\circ\text{C}$

Table 1.

Wavelength Bin [1]	Part Number	Typ Radiometric Power [2], mW		Max Wall-Plug Efficiency, %
		500mA	1000mA	
380-385nm	LHUV-0380-0150	175	370	12
	LHUV-0380-0200	225	475	15
	LHUV-0380-0250	275	580	18
	LHUV-0380-0300	325	685	21
385-390nm	LHUV-0385-0200	225	470	15
	LHUV-0385-0250	275	570	18
	LHUV-0385-0300	325	675	22
	LHUV-0385-0350	375	780	25
390-395nm	LHUV-0390-0300	330	695	22
	LHUV-0390-0350	375	790	25
	LHUV-0390-0400	425	900	28
	LHUV-0390-0450	470	1000	32
395-400nm	LHUV-0395-0350	375	765	25
	LHUV-0395-0400	425	870	28
	LHUV-0395-0450	475	970	31
	LHUV-0395-0500	525	1075	35
400-405nm	LHUV-0400-0400	435	875	28
	LHUV-0400-0450	475	960	31
	LHUV-0400-0500	525	1055	34
405-410nm	LHUV-0405-0500	525	1005	35
	LHUV-0405-0550	575	1100	38
	LHUV-0405-0600	625	1195	41
	LHUV-0405-0650	675	1295	45
410-415nm	LHUV-0410-0500	525	985	35
	LHUV-0410-0550	575	1080	38
	LHUV-0410-0600	625	1160	41
	LHUV-0410-0650	675	1255	45
415-420nm	LHUV-0415-0550	575	1070	39
	LHUV-0415-0600	625	1160	42
	LHUV-0415-0650	675	1250	46
420-425nm	LHUV-0420-0550	575	1060	39
	LHUV-0420-0600	625	1150	42
	LHUV-0420-0650	675	1245	46
425-430nm	LHUV-0425-0550	575	1070	39
	LHUV-0425-0600	625	1165	42
	LHUV-0425-0650	675	1260	46

Notes for Table 1:

1. Lumileds maintains a tolerance of $\pm 2\text{nm}$ for peak wavelength measurements.
2. Lumileds maintains a tolerance of $\pm 10\%$ for radiometric power measurements.

Other Characteristics, $T_j=25^\circ\text{C}$, Test Current = 500mA

Table 2.

Wavelength Bin ^[1]	Part Number	Forward Voltage, V			Typical Spectral Half-width, nm ^[2] $\Delta\lambda_{1/2}$	Typical Viewing Angle, degrees ^[3] $2\theta_{1/2}$	Thermal Resistance R_{th} , ^[4] $^\circ\text{C/W}$
		Minimum	Typical	Maximum			
380-385nm	LHUV-0380	2.5	3.2	3.5	9	125	6
385-390nm	LHUV-0385	2.5	3.1	3.5	10	125	6
390-395nm	LHUV-0390	2.5	3.1	3.5	10	125	5
395-400nm	LHUV-0395	2.5	3.1	3.5	11	125	4.5
400-405nm	LHUV-0400	2.5	3.1	3.5	11	125	4.5
405-410nm	LHUV-0405	2.5	3.0	3.5	12	125	4.5
410-415nm	LHUV-0410	2.5	3.0	3.5	13	125	4
415-420nm	LHUV-0415	2.5	3.0	3.5	14	125	3.5
420-425nm	LHUV-0420	2.5	3.0	3.5	14	125	3.5
425-430nm	LHUV-0425	2.5	3.0	3.5	14	125	3.5

Notes for Table 2:

1. Lumileds maintains a tolerance of $\pm 2\text{nm}$ for peak wavelength measurements.
2. Spectral width at $1/2$ of the peak intensity.
3. Viewing angle is the off axis angle from lamp centerline where the radiometric power intensity is $1/2$ of the peak value.
4. R_{th} between junction and electrode pads.

Absolute Maximum Ratings

Table 3.

Condition	Absolute Maximum Rating
Forward Current (mA)	1000mA
Junction Temperature ^[1]	135 $^\circ\text{C}$
ESD Sensitivity	Class 3B 8kV HBM JEDEC JS-001-2012
Operating Temperature	-40 $^\circ\text{C}$ – 135 $^\circ\text{C}$
Storage Temperature	-40 $^\circ\text{C}$ – 135 $^\circ\text{C}$
Reverse Voltage	LUXEON Z UV LEDs are not designed to be driven in reverse bias.

Notes for Table 3:

1. Proper current derating must be observed to maintain junction temperature below the maximum. Maximum junction temperature dependant on wavelength bin and drive current. See ABI 14 for derating curve.

Mechanical Dimensions

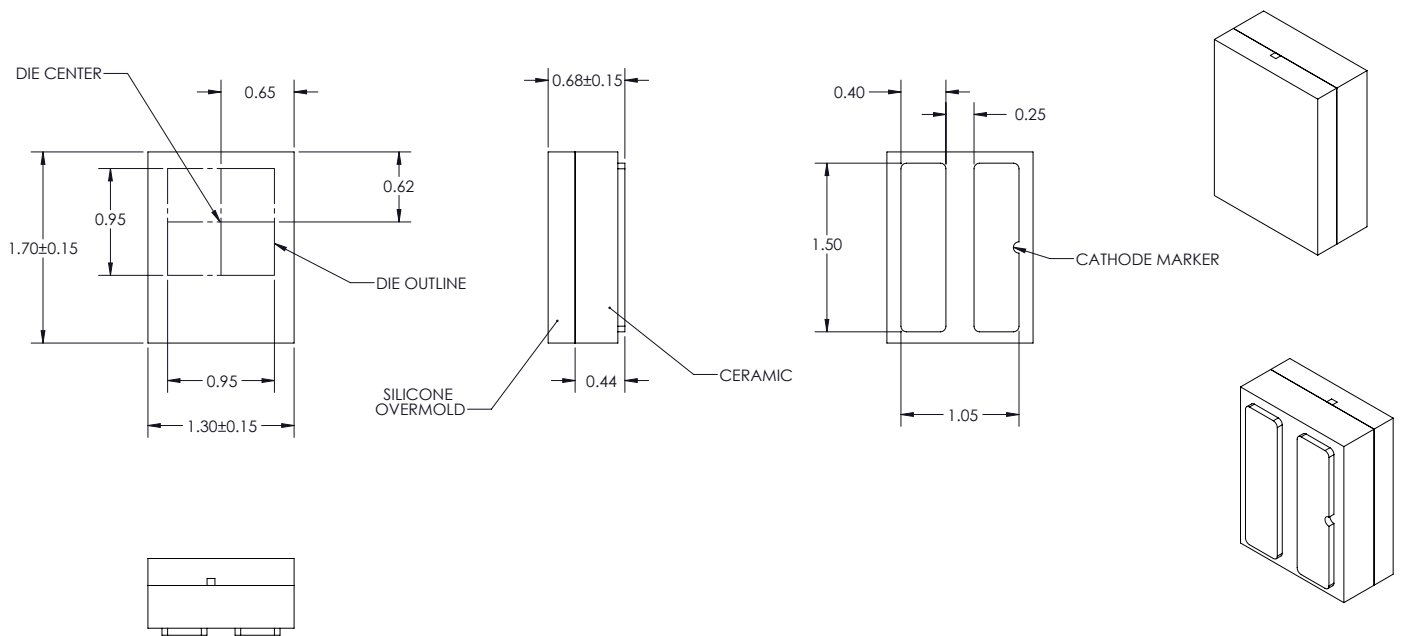

Figure 1. Package outline drawing.

Notes for Figure 1:

1. All dimensions are in millimeters.
2. To avoid damage, do not manually exert force to the top surface. See ABI 14 for handling precautions.
3. Drawings not to scale.

Solder Pad Design

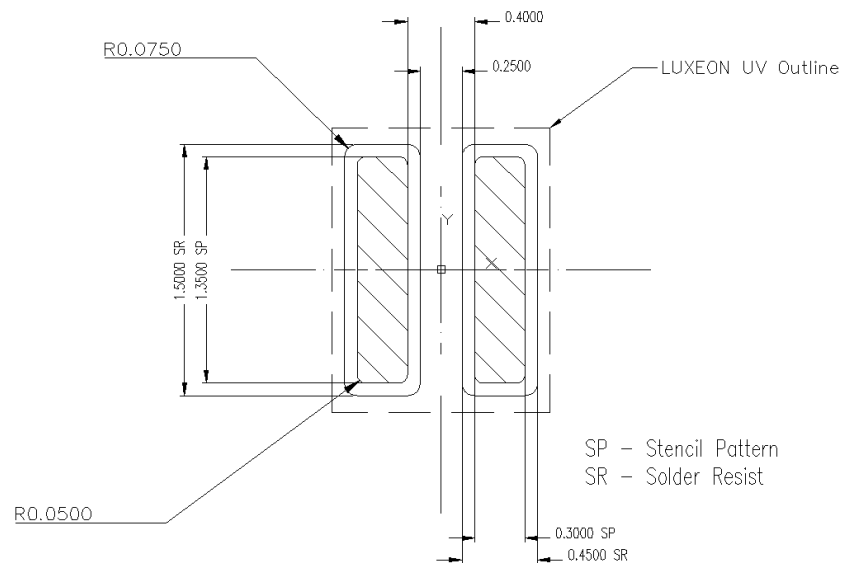

Figure 2. Solder pad layout.

Notes for Figure 2:

1. All dimensions are in millimeters.

JEDEC Moisture Sensitivity

Table 4.

Level	Floor Life		Soak Requirements Standard	
	Time	Conditions	Time	Conditions
I	unlimited	$\leq 30^{\circ}\text{C} / 85\% \text{ RH}$	168h + 5 / - 0	$85^{\circ}\text{C} / 85\% \text{ RH}$

Reflow Soldering Characteristics

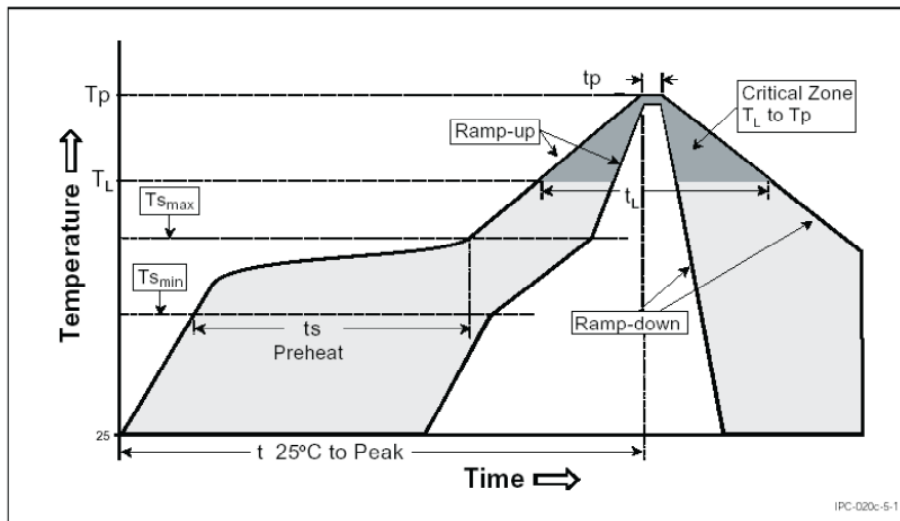

Figure 3. Reflow soldering conditions.

Table 5.

Profile Feature	Lead Free Assembly
Average Ramp-Up Rate ($T_{s_{max}}$ to T_p)	$3^{\circ}\text{C} / \text{second max}$
Preheat Temperature Min ($T_{s_{min}}$)	150°C
Preheat Temperature Max ($T_{s_{max}}$)	200°C
Preheat Time ($t_{s_{min}}$ to $t_{s_{max}}$)	60 - 180 seconds
Temperature T_L (t_L)	217°C
Time Maintained Above Temperature T_L (t_L)	60 - 150 seconds
Peak / Classification Temperature (T_p)	260°C
Time Within 5°C of Actual Peak Temperature (t_p)	20 - 40 seconds
Ramp-Down Rate	$6^{\circ}\text{C} / \text{second max}$
Time 25°C to Peak Temperature	8 minutes max

Note for Table 5:

- All temperatures refer to the application Printed Circuit Board (PCB), measured on the surface adjacent to the package body.

Typical Characteristic Curves

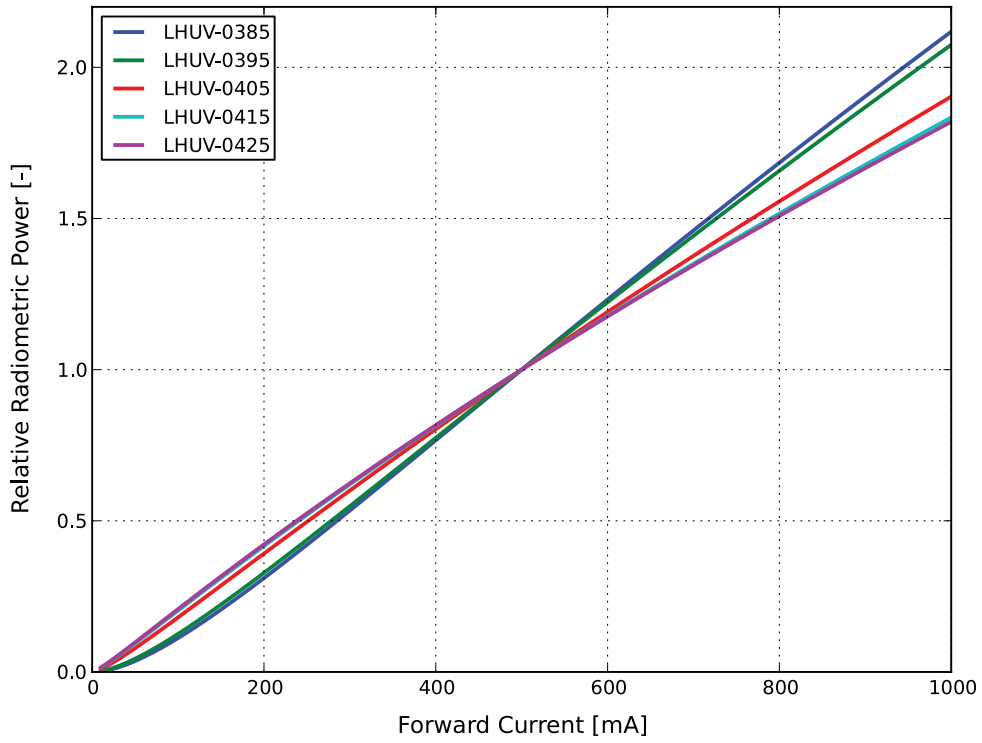

Figure 4. Typical relative radiant flux vs. forward current, $T_j = 25^\circ\text{C}$.

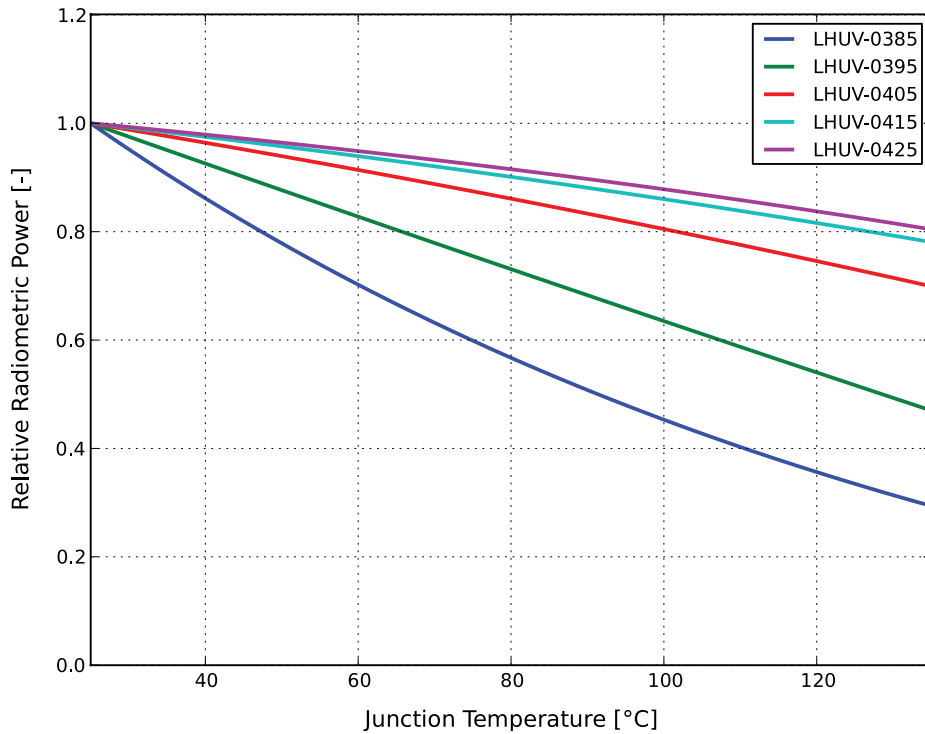

Figure 5. Typical relative radiant flux vs. junction temperature, test current = 500mA.

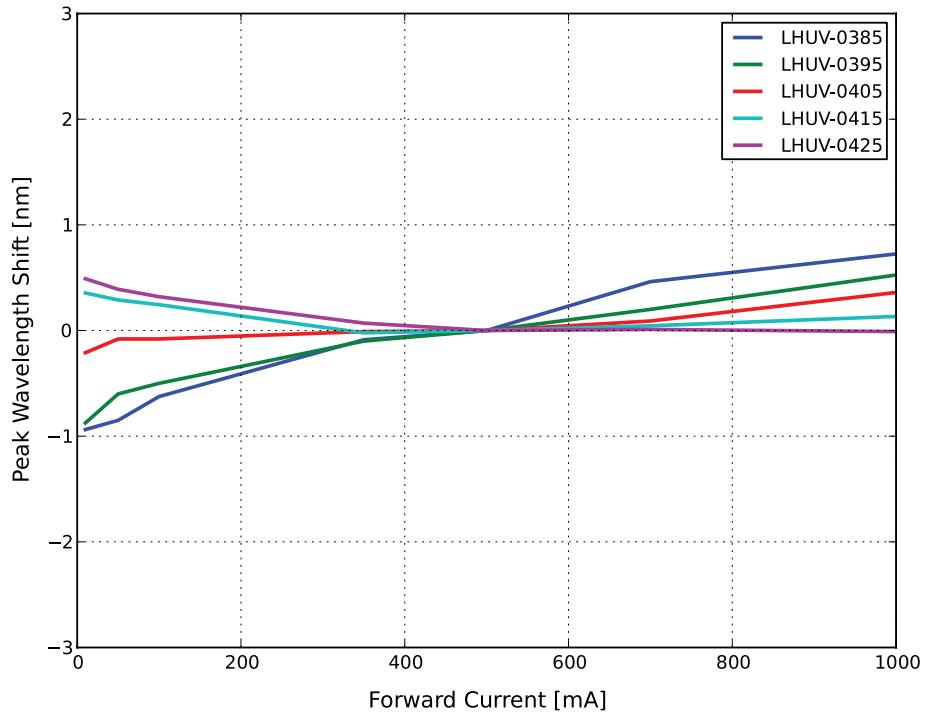

Figure 6. Typical peak wavelength vs. forward current, $T_j = 25^\circ\text{C}$.

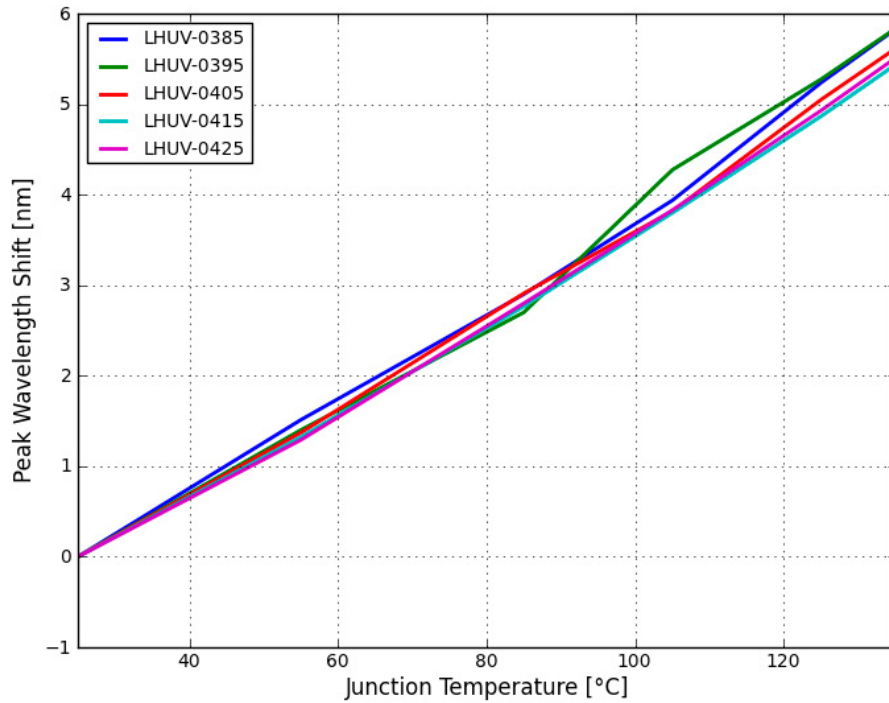

Figure 7. Typical peak wavelength vs. junction temperature.

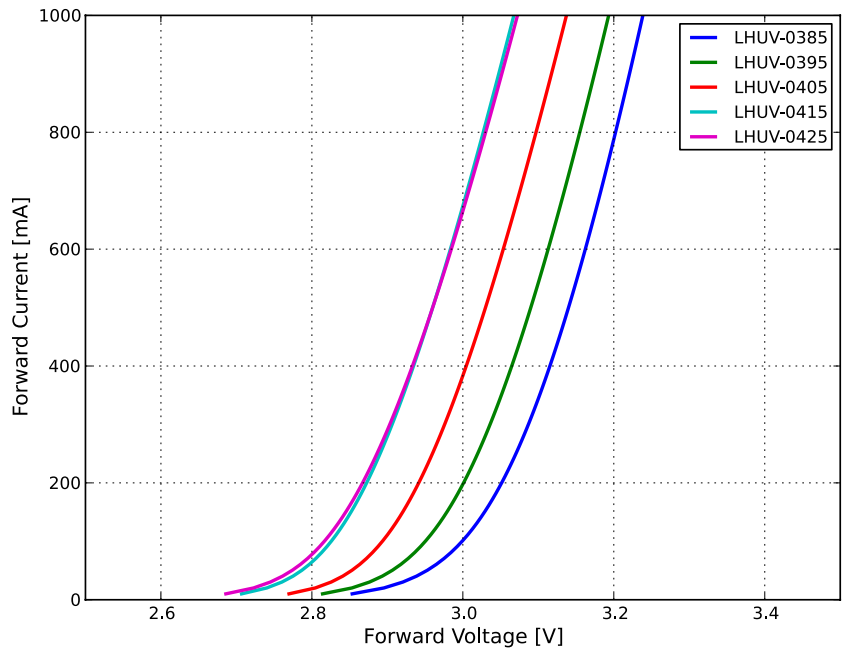

Figure 8. Typical forward current vs. forward voltage, $T_j = 25^\circ\text{C}$.

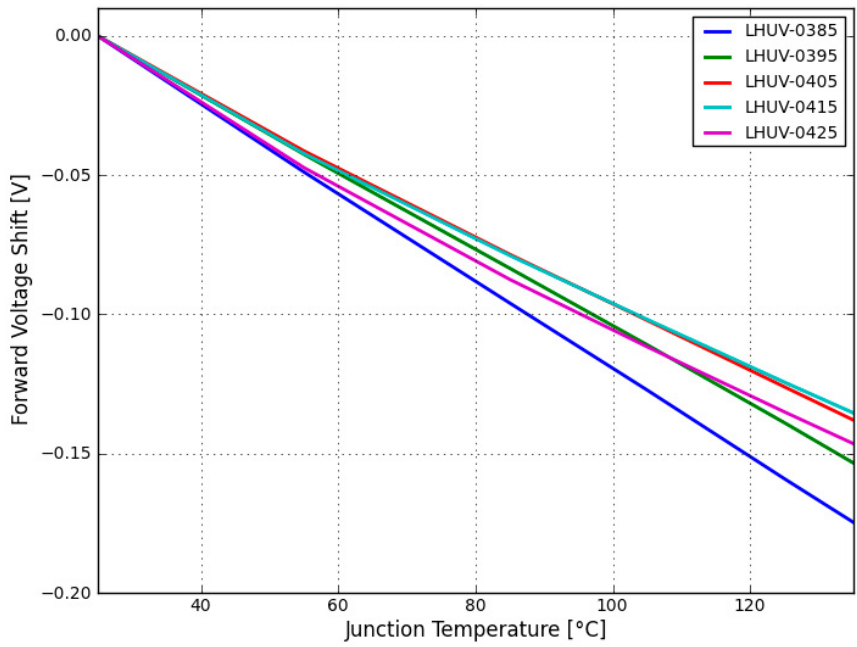

Figure 9. Typical forward voltage vs. junction temperature.

Typical Radiation Patterns

Typical Spatial Radiation Pattern

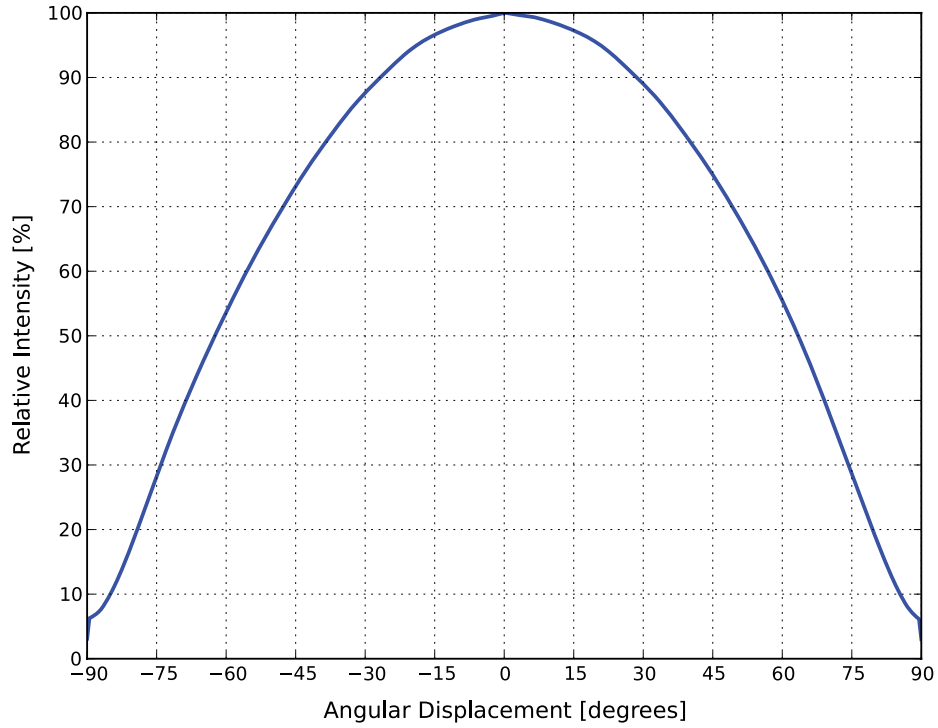

Figure 10. Typical spatial radiation pattern.

Typical Polar Radiation Pattern

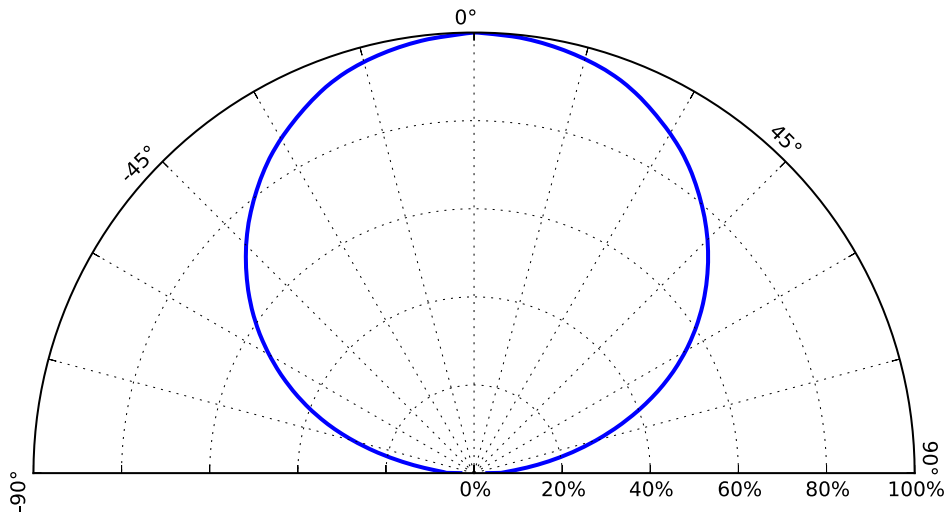

Figure 11. Typical polar radiation pattern.

Flux and Wavelength Bin Availability

Table 6 highlights standard radiometric power and wavelength bins in grey. Although several bins are outlined, product availability in a particular bin varies by production run.

Table 6.

Minimum Radiometric Power	Wavelength Bin / Part Number									
	380-385nm	385-390nm	390-395nm	395-400nm	400-405nm	405-410nm	410-415nm	415-420nm	420-425nm	425-430nm
	LHUV-0380	LHUV-0385	LHUV-0390	LHUV-0395	LHUV-0400	LHUV-0405	LHUV-0410	LHUV-0415	LHUV-0420	LHUV-0425
150mW										
200mW										
250mW										
300mW										
350mW										
400mW										
450mW										
500mW										
550mW										
600mW										
650mW										

Emitter Pocket Tape Packaging

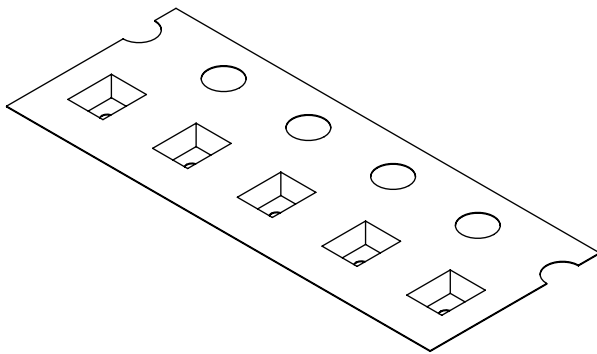
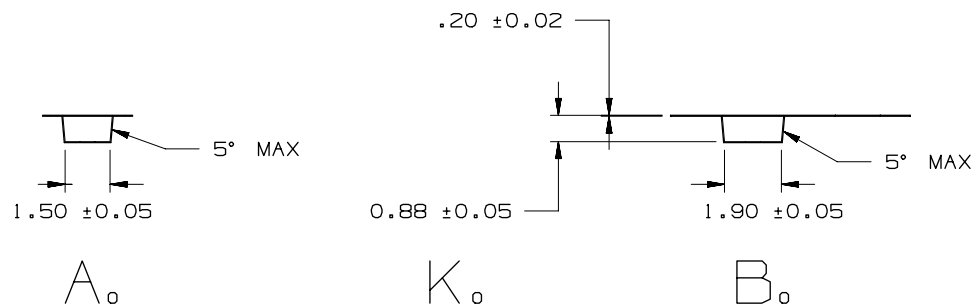
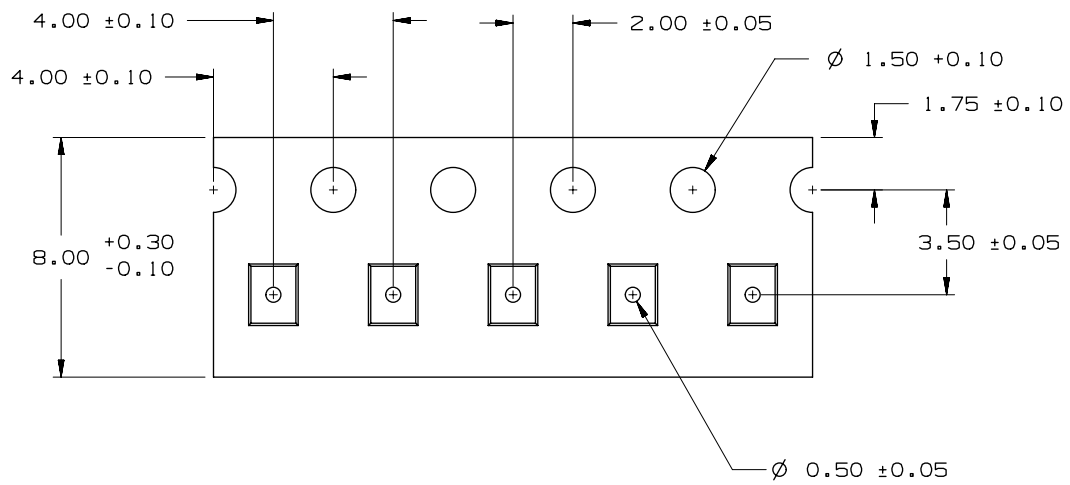

Figure 12. Emitter pocket tape packaging.

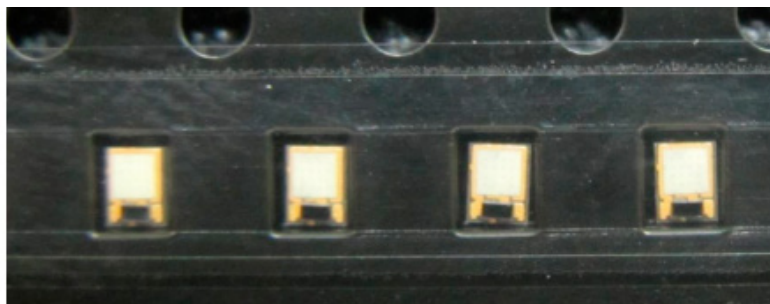

Figure 13. Orientation of LEDs inside carrier tape.

Emitter Reel Packaging

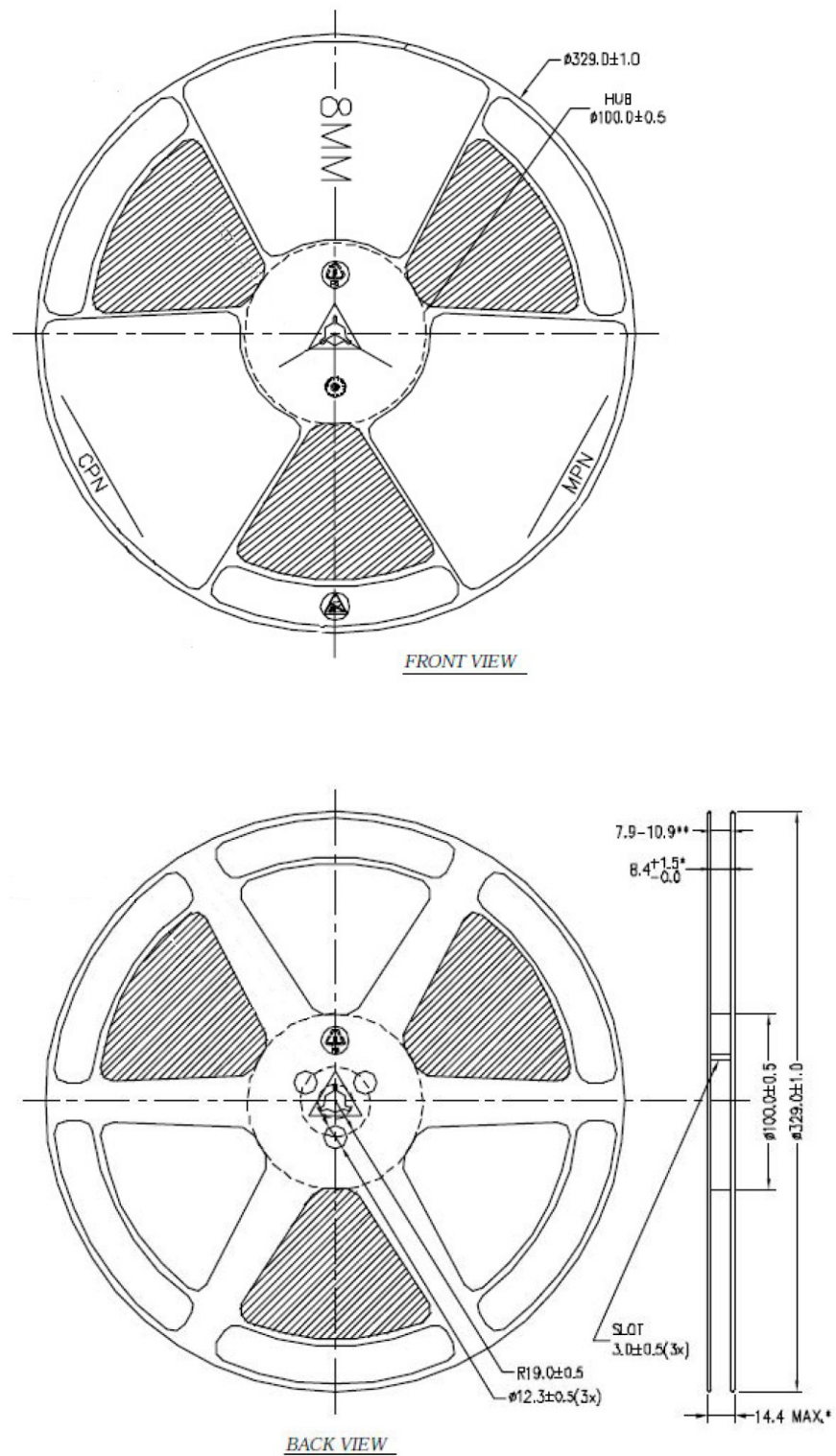

Figure 14. Emitter reel packaging.

About Lumileds

Lumileds is the light engine leader, delivering innovation, quality, and reliability.

For 100 years, Lumileds commitment to innovation has helped customers pioneer breakthrough products in the automotive, consumer and illumination markets.

Lumileds is shaping the future of light with our LEDs and automotive lamps, and helping our customers illuminate how people see the world around them.

To learn more about our portfolio of light engines visit www.lumileds.com.



©2015 Lumileds Holding B.V. All rights reserved.
LUXEON is a registered trademark of the Lumileds Holding B.V.
in the United States and other countries.

www.lumileds.com

Lumileds Holding B.V. shall not be liable for any kind of loss of data or any other damages, direct, indirect or consequential, resulting from the use of the provided information and data. Although Lumileds Holding B.V. has attempted to provide the most accurate information and data, the materials and services information and data are provided "as is" and Lumileds Holding B.V. neither warranties, nor guarantees the contents and correctness of the provided information and data. Lumileds Holding B.V. reserves the right to make changes without notice. You as user agree to this disclaimer and user agreement with the download or use of the provided materials, information and data.